

Complete Manual for the Installation and Maintenance of an Ecoglo Safety Way Guidance System

Ecoglo photoluminescent products used to mark Safety Way Guidance Systems (SWGS) are in accordance with CAN/ULC-S572, Standard for Photoluminescent and Self-Luminous Exit Signs and Path Marking Systems. Ecoglo SWG should be installed as per the directions in this manual, which conform to ULC509S, the Canadian Standard for Installation and Use of a Safety Way Guidance System

BASIC PRINCIPLES FOR THE DESIGN OF ECOGLO SAFETY WAY GUIDANCE

Photoluminescent safety way guidance systems provide, building occupants with consistent, coherent information so that they can be evacuated efficiently from any occupancy to a safe area.

The purpose of the Safety Way Guidance System is to provide luminous markings that provide an outline of the egress path and mark any changes in elevation, obstructions, or changes in direction. The purpose is not to provide illumination of the area.

Activation/charging of photoluminescent components to produce light emission in dark surroundings requires pre-exposure of the components to the installed light sources. The luminance performance during the decay mode of the photoluminescent components depends upon the light spectral characteristics of the light source, the excitation illuminance at the location of the photoluminescent component and the duration of the excitation.

All the components of an activated safety way guidance system shall have a luminance contrast with the surroundings when in use and for at least the time allocated for escape in normal conditions. For the same performance of luminous material, the observation distance for visibility of emergency exit door marking is longer than the distance for identification of the emergency egress / means of egress sign at the exit door.

In conditions of smoke on the emergency egress/means of egress, the light from luminous safety way guidance system components is attenuated exponentially with smoke density and light is scattered producing a luminous veil. As the smoke density increases, an emergency exit door may no longer be visible but the guidance lines and emergency egress / means of egress signs in short distance from the evacuee can be visible to direct evacuees towards an emergency exit door. In smoke conditions, evacuees may bend forward or crawl, reducing their speed of movement and increasing the evacuation time to a safe area.

Marking Continuity

Ecoglo SWGS components shall be arranged so as to be continuously and unbroken as possible from within the occupied area to the assembly area. Way guidance lines shall be used to provide a visually continuous, conspicuous line from within the building to a final point of the emergency egress / means of egress and shall preferably be a complete delineation of the boundaries of the emergency egress/means of egress.

NOTE: The final point of the emergency egress / means of egress can be inside or outside the building, depending on the evacuation strategy.

Visual Reinforcement

Emergency egress / means of egress signs shall be placed at intervals sufficient to provide consistency and continuity of information.

The frequency and visual reinforcement of emergency egress / means of egress signs at intermediate location and low location shall be at decision points in the emergency egress / means of egress route.

Emergency egress / means of egress signs positioned at low location shall be close to the way guidance lines or be incorporated in the guidance line, where ever practical, emergency egress/means of egress signs located at intermediary level shall be repeated at low location.

Location

Low location shall be the principal position for guidance lines. The height of the low location guidance lines shall be no higher than 300 mm from the floor, and lower may be preferred.

Intermediate guidance lines may be placed from 300 mm to a maximum of 1200 mm from the floor to provide visual reinforcement and to assist in the identification of guide rails, handrails or other.

Emergency egress / means of egress signs shall be located to ensure visual reinforcement to indicate emergency egress / means of egress direction or intermediate and final destinations on the emergency egress / means of egress.

The visual field between 1.20 m and 1.80 m on the walls of the emergency egress / means of egress may be used for visually reinforcing directional information

Destination

Final and intermediary destinations along the emergency egress / means of egress such as exit doors on the route and assembly/refuge areas/escape windows shall be identified using SWGS components.

Decision Points

SWGS shall provide signage at decision points to unambiguously and clearly alternative emergency egress / means of egress routes.

Multi-level facilities

SWGS in multi-level facilities shall include a photoluminescent or self-luminous floor / level numbering and stair identification signage at or near exit doors.

VERIFICATION

Each safety way guidance system shall be inspected to confirm that the installation is in accordance with the design and to ensure they operate as per their design.

The verification report shall include but not limited to:

- A date of verification and the printed name and signature of the person performing the verification;
- B list of components used that meet the requirements of CAN/ULC-S572; and
- C type of light source and level of illumination;

A qualified person shall verify by visual inspection that all components have been installed in accordance with this Standard.

Additions, deletions, or modifications to the safety way guidance system shall be verified in accordance with the requirements of this manual.

INSPECTION AND MAINTENANCE

Photoluminescent systems shall be visually inspected at intervals not greater than 12 months, and all missing, damaged and worn components shall be replaced.

Photoluminescent systems shall be inspected annually by:

- A inspecting surrounding light sources and ensure they meet the manufacturers specifications for activation and charging; and
- B inspecting luminescence of Exit Signs and Path Marking Systems for luminance contrast (see Appendix Note Action by: Michele and Al Cavers and Carlson).

Photoluminescent systems shall be inspected monthly by:

- A inspecting exit signs and path marking systems to ensure that the integrity of the system is maintained and that the components are continuous and unbroken from the occupied area to the assembly area;
- B Deficiencies shall be noted and promptly repaired; and
- C inspecting surrounding light sources to ensure they are fully operational.

DOCUMENTATION AND LOGBOOK

Records shall be made and the original or a copy shall be retained at the premises for examination by the authority having jurisdiction.

The initial verification or test reports for each system shall be retained throughout the life of the systems.

The log of required inspections, including the results and any corrective measures taken, shall be kept and maintained on the premises for inspection. The log shall contain the date of inspection and the printed name and signature of the person performing the inspection.

Records of tests, inspections, maintenance or operational procedures undertaken after the initial tests shall be retained so that at least the current and the immediately preceding records are available.

No record shall be destroyed within two years of having been prepared.

A logbook shall be provided to record dates and inspection details and may include:☐

- A initial verification report;
- B all modifications and results of inspection/maintenance;
- C manufacturer's installation and operation instructions; and
- D inspection records.

EXAMPLE OF EMERGENCY MEANS OF EGRESS SIGNS TO BE USED WITH OR WITHOUT SUPPLEMENTARY TEXT









Meaning as viewed from in front of the sign	Using graphical symbol and supplementary arrow only
Proceed down to the right (indicating change of level).	
a) Proceed up to the right (indicating change of level). b) Proceed forward and across to the right from here when suspended within an open area.	
Proceed down to the left (indicating change of level).	
a) Proceed up to the left (indicating change of level). b) Proceed forward and across to the left from here when suspended within an open area.	
a) Proceed forward from here (indicating direction of travel). b) Proceed forward and through from here; when sign is sited above door (indicating direction of travel). c) Proceed forward and up from here (indicating change of level).	
Proceed to the right from here (indicating direction of travel).	
Proceed to the left from here (indicating direction of travel).	
Proceed down from here (indicating direction of travel).	

FIGURE 3

EXAMPLE OF EXIT DOOR MARKINGS

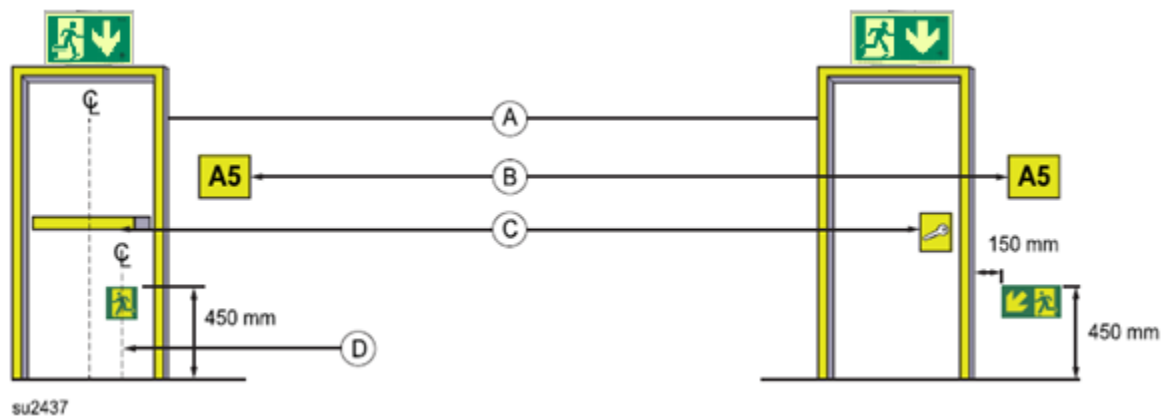

Example of Exit Doors

- A Doorframe markings (Clause B1.3)
- B Identification sign (Clause B1.4)
- C Hardware markings (Clause B1.2)
- D Vertical centerline of sign centred with door or located in half of door containing latches (Clause B1.1)

3A

3B

EXIT DOORS AT EXIT STAIRWAY SHAFTS

Markings are required on:

- A doors opening to “exits” or “exit passageways” to an exit stair shaft;
- B doors opening to “corridors” where such “corridors” act as required “exit passageways” connecting two “vertical exits”; and
- C doors serving as “horizontal exits”. All such doors, other than intermediate or final exit doors, should be marked in compliance with B.1.1 of this Guide. Intermediate and final exit doors

Photoluminescent material (PLM) markings should be provided to identify the entry points to the emergency exit doors on each floor. An exit path marking system should be installed in all stairways that could be a means of egress. The recommended installation is based on study findings conducted by the National Research Council Canada (NRC) and Public Works and Government Services Canada (PWGSC) [1] and [2].

EXIT DOORS AT EXIT STAIRWAY SHAFTS

Markings are required on:

- A: doors opening to “exits” or “exit passageways” to an exit stair shaft;
- B: doors opening to “corridors” where such “corridors” act as required “exit passageways” connecting two “vertical exits”; and
- C: doors serving as “horizontal exits”. All such doors, other than intermediate or final exit doors, should be marked in compliance with B.1.1 of this Guide. Intermediate and final exit doors should comply with B.2.7 of this Guide.

Such marking is not required for main entrance-exit doors.

EGRESS MARKING

The entry point of doors in egress routes at exit stairway shafts should be marked with a PLM door exit sign made in safety green, with the emergency exit symbol (running man) (See Figures 3 and 4) and an arrow (see Figure 5). The top of the sign should not be higher than 450 mm above the finished floor. The sign should be installed either on the door itself, or on the wall surface directly adjacent to the door on the latch-side. See Figure B1.

For the door-mounted option, the vertical centerline of the sign should be centered with the door, or should be in the half of the door, either the right or left, that contains the latch. In case of double-doors, both doors should be marked and the signs should be in the center of the doors. For door-mounted signs, arrows may be omitted.

For the wall-mounted option, the sign should be mounted on the wall surface directly adjacent to the latch-side of the door, as close as practicable to the door but in no case more than 150 mm from the door to the edge of the sign. In the case of double-doors, signs should be placed on the wall surface directly adjacent to the hinge-sides of both doors. Where the wall surface directly adjacent to the latch side is too narrow to accommodate the sign, the door-mounted option is preferred, but the sign may be placed on an adjacent perpendicular wall. Arrows are mandatory for wall-mounted signs.

FIGURE B1

EXIT DOOR MARKING

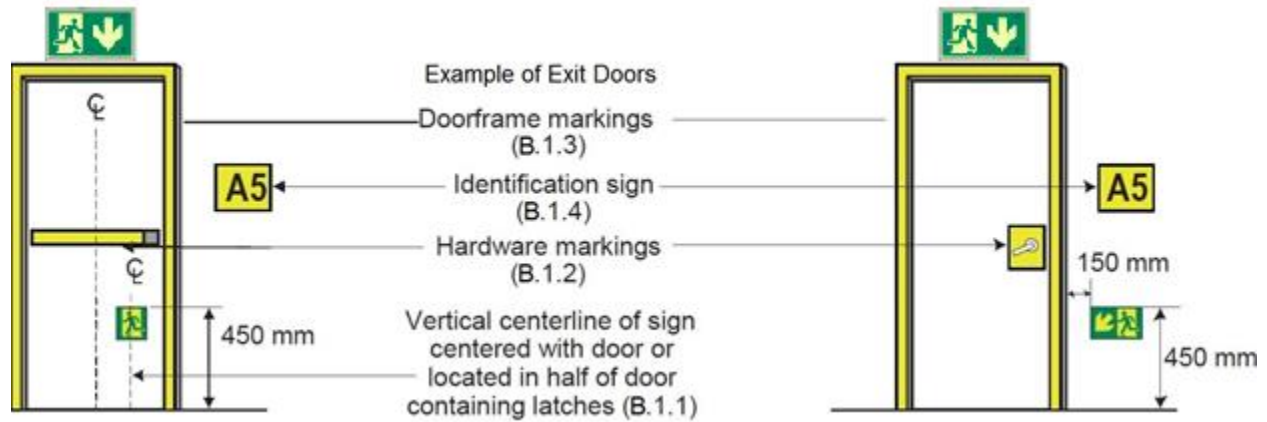

HARDWARE (KNOBS, ETC.)

Door handles or opening devices on emergency exit doors should be highlighted with PLM. Doorknobs and latches should be marked by placing a 100 x 100 mm piece of PLM behind the hardware or by applying a strip of PLM directly to push-pads, bars or panic hardware (see Figure B1).

DOORFRAMES

The entire perimeter of doorframes of exit doors should be marked with strips of PLM not less than 25 mm in width (see Figure B1).

IDENTIFICATION SIGN FOR FLOOR AND STAIR NAME

The floor number and stairway name should be mounted at shoulder height, permanently on the wall at the latch side of the door to an exit stair shaft.

EXIT STAIRS

Minimum requirements for exit stairs include markings within “vertical exits” (e.g. stairway, ramp), horizontal extensions in “vertical exits” (e.g. extended landing or corridor within a stairway), “horizontal exits” (e.g. bridge or tunnel between two buildings), “supplemental vertical exits” (e.g. stairway or ramp from an area of refuge), and “exit passageways” (e.g. passage leading from a yard or court to an exterior space). Such markings are not required in “street level lobbies”, “exterior stairs”, or “exterior balconies”.

STEPS

The entire horizontal leading edge of each step should be marked with a solid and continuous strip of PLM. The dimensions, distances and locations should be consistent and uniform throughout the same exit as shown in Figure B2.

FIGURE B2 STAIR MARKING

Ecoglo step edge contrast strips should be installed as follows:

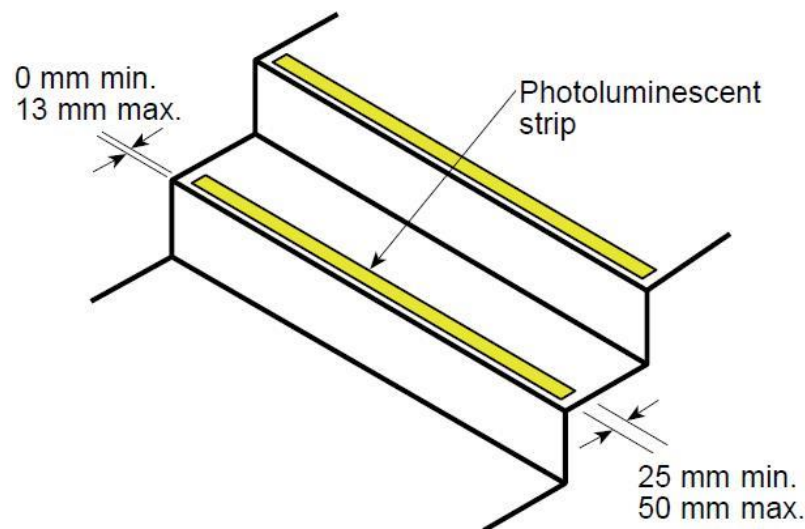

The strips should extend for the full width of each step.

The placement of the strips on the leading edge of the step should be:

- Maximum: 13 mm from the leading edge of the step
- Minimum: 0 mm from the leading edge of the step.

The installation of PLM markings must not result in tripping or slipping hazards. Proper physical installation follows in appendix A.

HANDRAILS

All handrails and handrail extensions should be marked with a solid and continuous strip of PLM. Ecoglo H series handrail matching the radius of a round handrail should be used on round handrails. G series flat guidance strip should be used on flat handrails. The dimensions, distances and locations should be consistent and uniform throughout the same exit (see Figure B4).

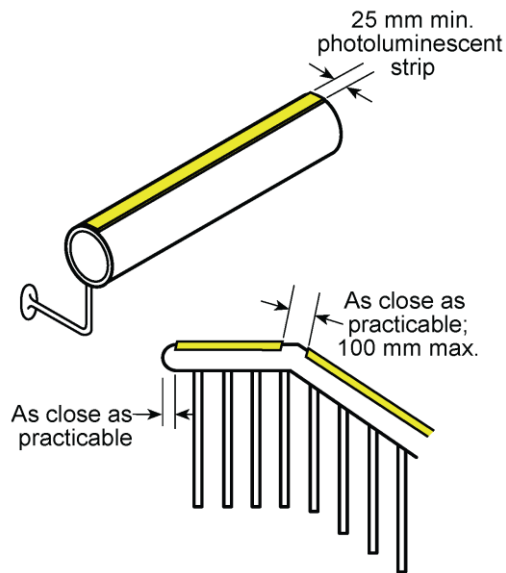

HANDRAIL MARKING

The minimum width of the strip should be 25 mm. The strip should be placed at least on the top surface of all handrails along their entire lengths and include handrail extensions, and newel post caps.

Where handrails or handrail extensions bend or turn corners, PLM strips should be as continuous as practicable and no discontinuity should be greater than 100 mm.

In existing buildings where handrail material or design makes it difficult to apply PLM on the top surface, a PLM strip at least 25 mm wide may be placed on the side of a handrail.

FLOOR PERIMETER DEMARCATION LINES

Ecoglo floor perimeter demarcation lines are intended to outline the egress path by providing pathway marking lines on both sides of the path (see Figure B5 and Figure B6). Stair landings and other parts of the egress route should be provided with floor perimeter demarcation lines. The lines should be solid and continuous and use G6001 guidance strip if possible. The continuity of the demarcation lines may be interrupted to accommodate obstructions such as conduits, mouldings, corners or bends, but discontinuities should not exceed 100 mm. The dimensions, distances and locations should be uniform and consistent throughout the same exit. Demarcation lines should be located on the walls/vertical surface.

Floor-mounted option: Perimeter demarcation lines may be located on the floor if the option of marking the walls is not acceptable. They should be placed as close as practicable to the wall, and should extend to within 50 mm of the markings on the leading edge of landings (see Figure B5). Where an obstruction (such as a standpipe) is located within the egress path, the demarcation line may extend across the floor so that the obstruction is outside of the outlined area. Demarcation lines on floors should continue across the floor in front of all doors, except in front of intermediate and final exit doors (see Figure B8).

FLOOR PERIMETER MARKING, FLOOR-MOUNTED OPTION

(Ecoglo suggests this option only be used when wall mounting is not possible)

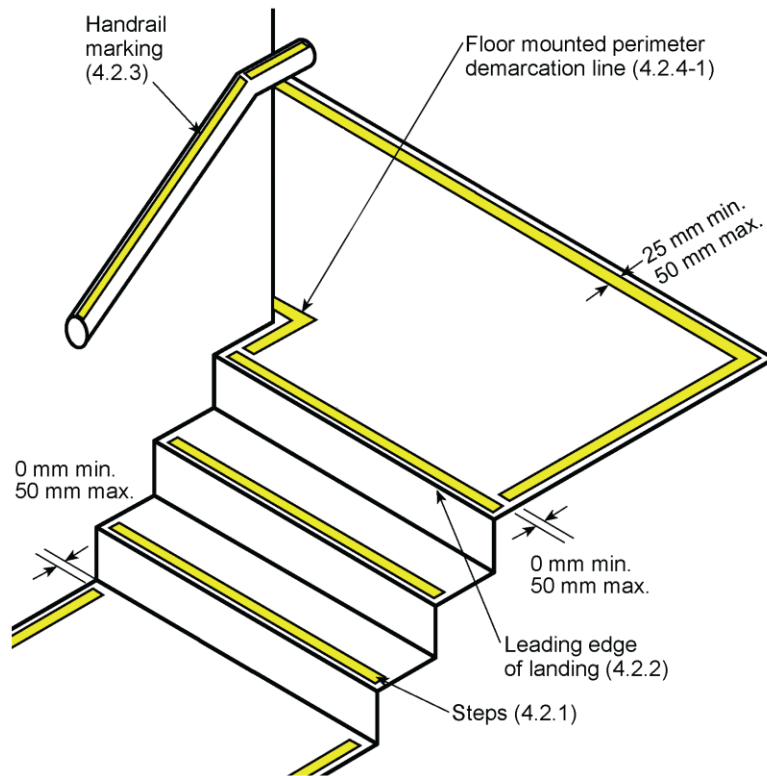

Wall-mounted option: Perimeter demarcation lines using G6001 Ecoglo guidance strips may be located on the wall with the bottom edge no more than 100 mm above the finished floor. At the top or bottom of stairs, demarcation lines should drop vertically to the floor within 50 mm of the step or landing edge (see Figure B6). Demarcation lines on walls should transition vertically to the floor and then extend across the floor where a line on the floor is the only practical method of outlining the path (for instance, to exclude obstructions or dead ends from egress pathways). Demarcation lines on walls should continue across the face of all doors, or may transition to the floor and extend across the floor in front of such doors, except in front of intermediate and final exit doors (see Figure B8). Perimeter demarcation lines are not required:

- A on the side of steps; and
- B where an area is selected not to be outlined because it is not part of the egress path, for example an obstruction or dead end.

FLOOR PERIMETER MARKING, WALL-MOUNTED OPTION (Ecoglo Recommends this option)

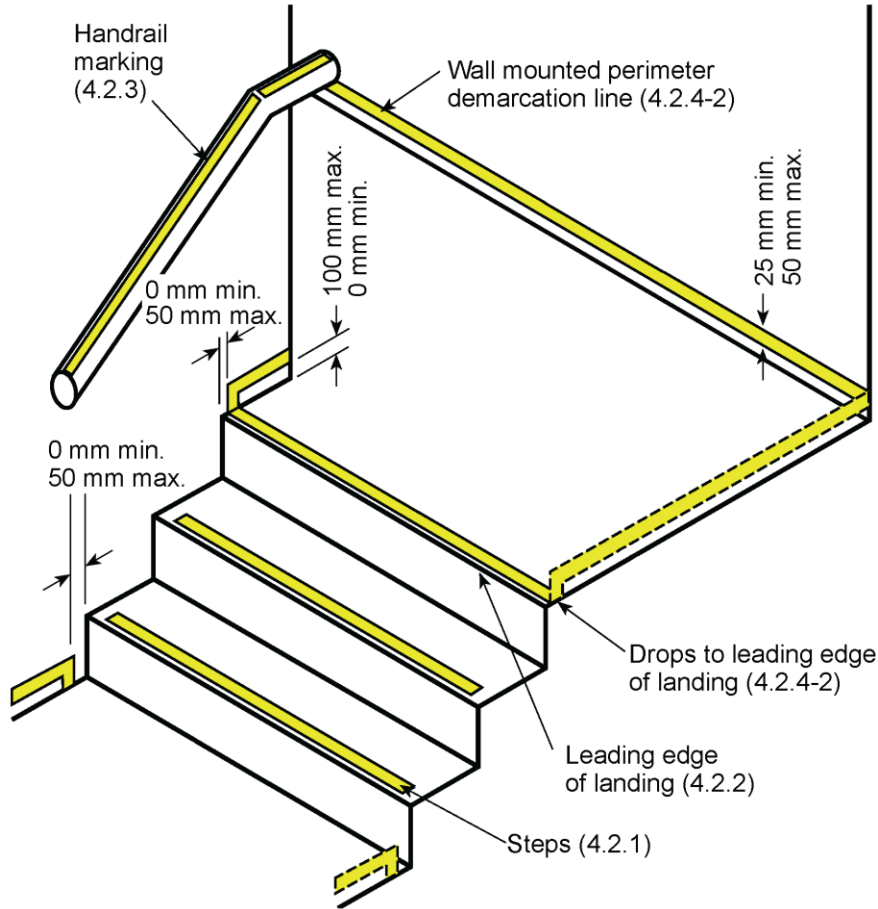

OBSTACLES (E.G., PIPES, HOSES, ETC.)

Obstacles at or below 1980 mm in height and projecting more than 100 mm into the egress path should be outlined with Ecoglo Obstruction markings. These markings are no less than 25 mm in width comprised of a pattern of alternating equal bands of photoluminescent material and black, with the alternating bands no more than 50 mm wide and angled at 45°. Examples of such obstacles include standpipes, hose cabinets, wall projections, and restricted height areas (see Figure B7).

OBSTACLES AND DEMARCATION LINES

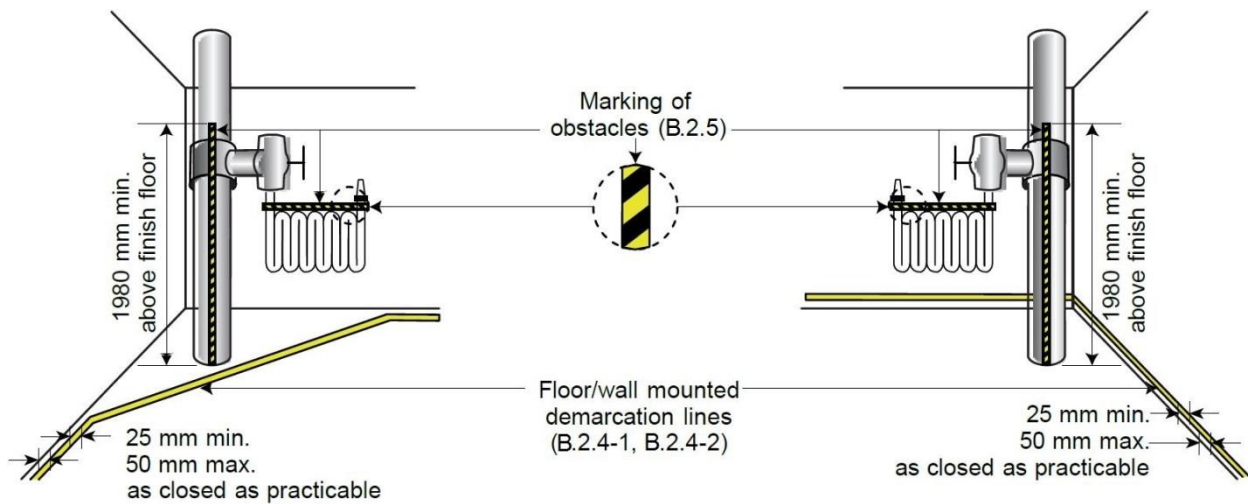

FINAL EXIT DOORS

Intermediate exit door: when travelling in the egress direction, a door that leads from a vertical exit, horizontal extension in a vertical exit, horizontal exit, supplemental vertical exit, or exit passageway, but does not lead directly to the exterior or to a street level lobby; and

Final exit door: a door leading directly to the exterior or a street level lobby.

INTERMEDIATE AND FINAL EXIT MARKING

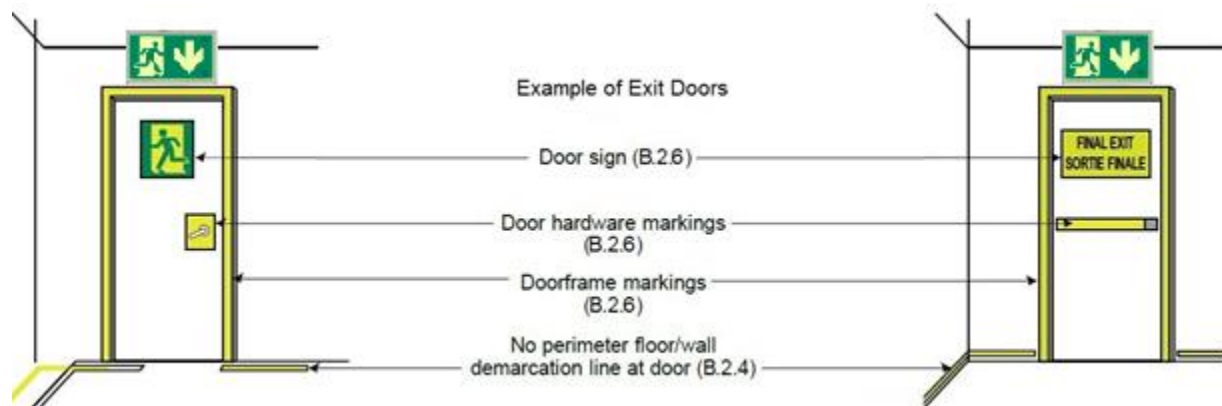

An intermediate exit door should have a PLM exit sign as described in Clause B1.1. At the final exit door, a door-mounted sign should contain text in sans serif letters. Examples of such texts are “FINAL EXIT”, or “EXIT THROUGH LOBBY” or “EXIT TO STREET”, or “EXIT TO CHAMBERS STREET”, etc (see Figure B8). Signs with text should meet applicable regulations regarding bilingual signage. These signs, exit sign or final exit sign, should be placed in the center of the door at 1200 to 1600 mm from the floor.

Door hardware on all intermediate and final exit doors should be marked with no less than 400 mm² of PLM. This marking should be located behind, immediately adjacent to, or on the door handle and/or escutcheon. On panic hardware, the PLM marking should be no less than 25 mm wide for the entire length of the actuating bar or touchpad. Hardware markings may include safety green graphics such as arrows indicating door handle turning directions, the emergency egress symbol (running man, see Figure 3), the word “PUSH”, and similar egress-related symbols provided a minimum 100 X 100 mm of PLM is maintained.

The top and sides of the door frame of all intermediate and final exit doors should be marked with a solid and continuous 25 mm to 50 mm wide strip of PLM. Gaps in the continuity of doorframe markings are permitted where a line is fitted into a corner or bend, but should be as small as practicable and in no case greater than 25 mm. Where a door moldings does not provide enough flat surface on which to locate the strip, the strips may be located on the wall surrounding the frame. The dimensions, distances

and locations of the required markings should be consistent and uniform on all doors on the route to the exterior of the building.

ADDITIONAL MARKINGS

Floor number and stairway identification: PLM signs should be placed adjacent to the exit door inside the stairway to identify the floor number and the stairway number and/or name. Such signs should contain sans serif letters at least 45 mm and should be located at 1200 mm to 1600 mm above the floor.

Directional signage at transfer levels: PLM directional signs should be provided in safety green, including the word “Transfer level” or “Crossover floor”, should be posted next to the exit door wherever re-entry to a floor or transfer to another means of egress is permitted. The sign should be located 1200 to 1600 mm above the floor and the lettering should be sans serif letters at least 25 mm high.

“Not An Exit” sign: PLM signs should be placed on doors along the egress path that lead to dead ends (mechanical rooms, storage closets, etc.) Such signs should contain black or red sans serif letters at least 25 mm high reading "NOT AN EXIT" and be placed on the door at 1200 mm to 1600 mm above the floor.

“No Roof Access” sign: In buildings where roof access is not possible for building occupants, PLM signs including the words “NO ROOF ACCESS” should be placed on the mid-landing wall 1200 to 1600 mm above the floor every 3 floors and on every floor for the 5 top floors of the stairway. The sign should contain black or red sans serif letters at least 25 mm high reading “NO ROOF ACCESS”.

Where direction is not clear, additional signage should be provided following the general guidelines.

Signs containing words should be provided in both official languages according to regulation.

Cleaning

Regular cleaning to remove built up dirt and objects on the strips will ensure Ecoglo will continue performing to expectation. Note that the photoluminescence will continue performing even after UV exposure or exposure to moisture. The only reason for degradation in the performance of the photoluminescence is a lack of correct cleaning.

1. Vacuuming or brushing with a stiff bristle head (wet or dry) is often enough to keep the strips clean. The glowing strip can also be wiped clean with a wet or dry sponge or cloth. Observation will determine if cleaning is required, however a regular cleaning every 4 to 6 weeks or after particularly heavy use should ensure correct performance.
2. High-pressure water (but not steam cleaning) can also be used to clean the strips.
3. Do not use highly alkaline or acidic cleaning agents. The pH of the cleaning agents should be between pH 5 and pH 12. If cleaning agents are applied at more than pH 10, the strips should be rinsed with pH neutral (pH 6 to pH 8) solution afterwards.



Tools Required

- Methylated spirits
- Glue gun
- Glue
- Roller
- Brush and pan
- Paint scraper
- Soft cloth
- Concrete Screws
 - 8 x 32mm (1 ¼ inch) countersunk square (#1) Stainless Steel AB self tapping screw.
- Anchor – 6mm x 30mm (0.25 x 1 3/16 inches) plastic anchor



2

Preparation of Surface

- You should not install Ecoglo nosings over the top of carpet.
- Remove the carpet from the edge of the strip and fix the nosing with adhesive and mechanical fixers to the substrate below.
- The carpet nosing is designed to aid in the replacement of your carpet.



Cutting Away Carpet

- Place the nosing firmly against the riser of the step.
- Release the nosing approximately 10mm (3/8ths of an inch).
- Using a sharp box-cutter type knife cut the carpet parallel to the nosing around all three sides.



- Remove the nosing and cut along the leading edge of the step.
- Remove the carpet and place the nosing firmly against the riser of the step.
- Line it up with your string line and mark the location of the drill holes.



- Using a 6mm (1/4 inch) masonry bit, drill the hole that will house the plastic anchor.
- Wipe away any dust or debris
- Thoroughly clean the surface with an industrial strength cleaner.
- Remove any paint or sealant
- Allow the surface to dry
- Place the anchor firmly into the holes

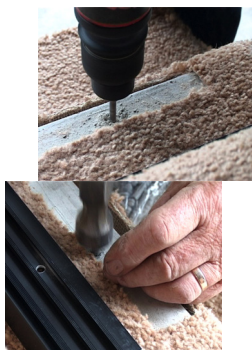

- Lay a 3mm (1/8 inch) bead in a wave pattern over the full length of the underside of the nosing.
- Keep the adhesive clear of the outside edge and the drill holes.
- **Note:** Ecoglo New Zealand installations use Bostik Seal n Flex FC. (US equivalent: Bostik 1100 FS) Expected usage of adhesive is: 22 metres (72ft, 2 inches) per 600ml sausage.



- Place the nosing firmly back onto the step, lining up the drill holes.
- Tighten the screws firmly - this will create a strong, even bond.





Tools required

- Methylated spirits
- Glue gun
- Glue
- Roller
- Brush and pan
- Paint scraper
- Soft cloth
- Concrete Screws
 - 8 x 32mm (1 1/4 inch) countersunk square (#1) Stainless Steel AB self tapping screw.
- Anchor – 6mm x 30mm (0.25 x 1 3/16 inches) plastic anchor



2

The image shows a collection of tools and materials laid out on a light-colored surface. From left to right, there is a glue gun, a bottle of methylated spirits, a brush in a pan, a paint scraper, a soft cloth, a concrete screw, and a plastic anchor.

Preparation of Surface

- Thoroughly clean the surface with an industrial cleaner.
- Remove any paint or sealant and then allow the surface to dry

The image shows three rectangular concrete blocks stacked on a surface. The top block is slightly offset to the right, and the middle block is offset to the left, creating a stepped appearance.

Alignment (for installation to more than one step)

- Place one piece of step nosing on the top step and one on the bottom step.
- Run a string line from the left edge of the top nosing to the left edge of the bottom nosing.
- This will give you a straight, true line.



• **NOTE:** The maximum recommended length for installation in outdoor situations is 1.5 metres (5 foot), with a minimum 5mm (1/8th inch) gap between lengths. This allows for thermal expansion in extreme weather conditions and also aids in water drainage off the step tread.

- Place the nosing firmly against the riser of the step.
- Line it up with your string line
- Mark the location of the drill holes
- Using a 6mm (1/4 inch) masonry bit, drill the hole that will house the plastic anchor

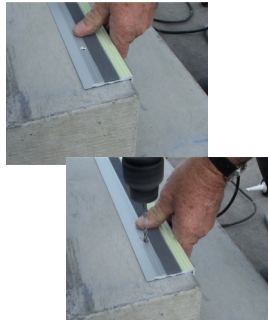

- Wipe away any dust or debris
- Place the plastic anchor fully in to the holes



- Lay a 3mm (1/8 inch) bead in a wave pattern over the full length of the underside of the nosing.
- Keep the adhesive clear of the outside edge and the drill holes.
- **Note:** *Ecoglo New Zealand installations use Bostik Seal n Flex FC. (US equivalent: Bostik 1100 FS) Expected usage of adhesive is: 22 metres (72ft, 2 inches) per 600ml sausage.*





- Place the nosing firmly back onto the step, lining up the drill holes.
- Tighten the screws firmly - this will create a strong, even bond.



VISIBLY BETTER

F Series Flat Stair Nosings on Carpeted Steps **Installation Instructions**

Tools Required

- Vacuum
- Soft Cloth
- Painters tape
- Fasteners with concrete nylon anchors (included)
- ¼” masonry drill bit
- Carpet punch (optional)
- Premium Polyurethane adhesive/sealant (Optional)
 - o Bostik 915 or Bostik 110 are recommended
- Caulking gun (Optional)

Installation procedure

- Place one piece of step nosing on the top step and one on the bottom step.
- Run a string line from the left edge of the top nosing to the left edge of the bottom nosing. This will give you a straight, true line.
- Place the nosing firmly against the riser of the step, lined up with the string line.
- Using a ¼” masonry bit, slowly drill a hole through the carpet and into the concrete flooring.
 - o Optional – Mark the hole locations and use a carpet punch to remove carpet at that section, or cut a small “X” at the drill location to ensure the drilling does not cause the carpet to run.
- Place the plastic anchor fully into the holes.
- Vacuum away any dust or debris
- Place the nosing firmly back onto the step, lining up the drill holes.
- Fasten the nosings into place using the supplied stainless steel fasteners, fastening into the concrete nylon anchors.

ECOGLO INC.

241 Main St., Suite 100 Buffalo, New York 14203

Tel (888) 679-4022 Fax (877) 679-4022

www.us.ecoglo.com



VISIBLY BETTER

Ecoglo S Series Cast-in-Place Stair Nosings

SUGGESTED INSTALLATION INSTRUCTIONS

STEP 1. Prepare the riser forms for the stairs in agreement with standard industry practice and all valid requirements. Ensure that the riser forms are straight and true. Straight and true riser forms will help ensure proper installation of the stair treads.

STEP 2. Pour the concrete to form the stairs.

NOTE: The use of very large aggregate or concrete with a very low slump will make installation of the stair nosing's difficult.

STEP 3. Using the S Series Cast-in-Place nosing, ensuring that the front of the profile is facing the front of the step, place the nosing into the fresh concrete. Ensure that the front edge of the nosing is flush with the riser form

ALL STAIR NOSINGS MUST BE SET LEVEL, PLUMB AND FLUSH ON THE TREAD AREA. FOR STEEL PAN STAIRS, THE BOTTOM OF THE FRONT PORTION OF THE STAIR NOSING MUST SIT TIGHTLY ON THE STEEL PAN RETURN.

STEP 4. Gently work the nosing into the concrete until the back edge of the nosing is level with the finished edge of the tread. Work the nosing into the concrete until it is level, flush with the tread, and at the proper elevation.

STEP 5. Repeat the procedures given in Step 3 and Step 4 above until all the stair nosings are installed and properly positioned.

STEP 6. After the concrete has taken its initial set, remove the riser forms, and finish the concrete riser flush to the stair nosing front or as otherwise specified.

Note: This is important to ensure that the riser has a clean finish.

STEP 7. To avoid unwanted glue residue on the stair nosings, remove the protective tape from them immediately after they have been installed.

ECOGLO INC.

241 Main Street, Suite 100, Buffalo, NY 14203

Tel (888) 679-4022 Fax (877) 679-4022

www.us.ecoglo.com



ECOGLO INC.
241 Main Street, Suite 100, Buffalo, NY 14203
Tel (888) 679-4022 Fax (877) 679-4022
www.us.ecoglo.com



VISIBLY BETTER

SUGGESTED INSTALLATION INSTRUCTIONS

STEP 1. Prepare the metal pan steps in agreement with standard industry practice and all valid requirements.

STEP 2. Pour the concrete to the metal pan stairs.

NOTE: The use of very large aggregate or concrete with a very low slump will make installation of the stair nosing's difficult.

STEP 3. Using the S11 Series, ensuring that the front of the profile is facing the front of the step, place the nosing into the fresh concrete. Ensure that the front edge of the nosing is flush with the front riser of the step.

STEP 4. Gently work the nosing into the concrete until the back edge of the nosing is level with the finished edge of the tread. Work the nosing into the concrete until it is level, flush with the tread, and at the proper elevation.

STEP 5. Repeat the procedures given in Step 3 and Step 4 above until all the stair nosings are installed and properly positioned.

STEP 7. To avoid unwanted glue residue on the stair nosings, remove the protective tape shortly after the product has been installed.

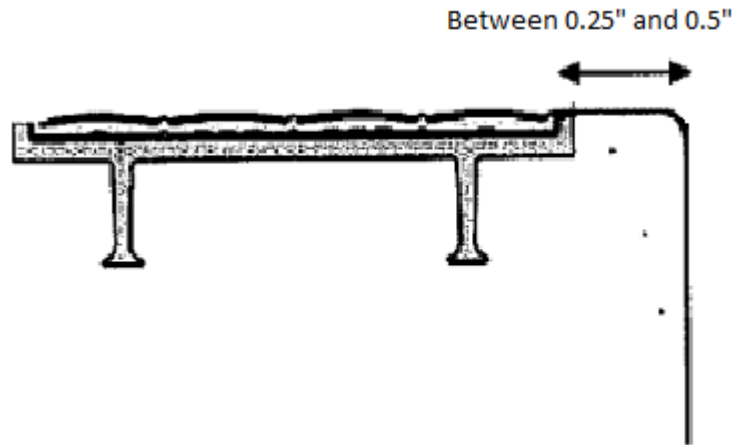

ECOGLO INC.

241 Main St., Suite 100 Buffalo, New York 14203

Tel (888) 679-4022 Fax (877) 679-4022

www.us.ecoglo.com



VISIBLY BETTER

SUGGESTED INSTALLATION INSTRUCTIONS

STEP 1. Prepare the riser forms for the stairs in agreement with standard industry practice and all valid requirements. Ensure that the riser forms are straight and true. Straight and true riser forms will help ensure proper installation of the stair treads.

STEP 2. Pour the concrete to form the stairs.

NOTE: The use of very large aggregate or concrete with a very low slump will make installation of the stair nosing's difficult.

STEP 3. Using the S2 Series, ensuring that the front of the profile is facing the front of the step, place the nosing into the fresh concrete. Ensure that the front edge of the nosing is flush with the riser form

STEP 4. Gently work the nosing into the concrete until the back edge of the nosing is level with the finished edge of the tread. Work the nosing into the concrete until it is level, flush with the tread, and at the proper elevation.

STEP 5. Repeat the procedures given in Step 3 and Step 4 above until all the stair nosings are installed and properly positioned.

STEP 6. After the concrete has taken its initial set, remove the riser forms, and finish the concrete riser flush to the stair nosing front or as otherwise specified.

Note: This is important to ensure that the riser has a clean finish.

STEP 7. To avoid unwanted glue residue on the stair nosings, remove the protective tape from them immediately after they have been installed.

ECOGLO INC.

241 Main Street, Suite 100, Buffalo, NY 14203

Tel (888) 679-4022 Fax (877) 679-4022

www.us.ecoglo.com



VISIBLY BETTER

ECOGLO WARRANTY POLICY

Ecoglo Inc. warrants that the products sold hereunder shall be free from defects in materials or workmanship for a period of five (5) years from the date of delivery. If Customer has a warranty claim it must notify Ecoglo Customer Service immediately so that a representative can inspect the product and if, in Ecoglo's judgment acting reasonably, the claim meets the terms of the product warranty, Ecoglo Inc. shall replace the defective products forthwith, provided always that Ecoglo Inc. shall not be responsible for any installation costs so incurred by Customer. The foregoing product warranty does not apply to and will be void in any of the following circumstances: (1) the products have been installed by an installer who has not received installation training by Ecoglo Inc.; or (2) the products have not been installed correctly in accordance with the official installation instructions that form part of this product warranty; or (3) the products have been modified; or (4) the products have been used outside of their stated specifications, capacity or operating parameters; or (5) the products have been improperly operated, maintained or repaired; or (6) the products have been misused, damaged, abused or involved in an accident.

To request installation training for the products, please contact Ecoglo Customer Service at (888) 679-4022 ext. 107 or e-mail sales@accessproducts.com. In order to validate your warranty, please submit a signed copy of this Purchase Order contract to Ecoglo Customer Service.

ECOGLO INC.
241 Main Street, Suite 100, Buffalo, NY 14203
Tel (888) 679-4022 Fax (877) 679-4022
www.us.ecoglo.com

**Threshold Strip
Installation Guide**

Preparation of Surface

- Ensure the mounting surface is clean of dirt, dust and debris.
- If a sealant has been applied to the concrete steps we recommend contacting your local adhesive representative to check compatibility.



Alignment (for installation to more than one step)

- Place one piece of step nosing on the top step and one on the bottom step.
- Run a string line from the left edge of the top nosing to the left edge of the bottom nosing.
- This will give you a straight, true line.
- **NOTE:** *The maximum recommended length for installation in outdoor situations is 1.5 metres (5 foot), with a minimum 5mm (1/5" inch) gap between lengths. This allows for thermal expansion in extreme weather conditions and also aids in water drainage off the step tread.*



- Using a cartridge glue gun apply a 3mm (1/8 inch) bead of the recommended polyurethane adhesive in a weaving pattern along the full length of the underside of the nosing



- **Note:** Ecoglo New Zealand installations use Bostik Seal n Flex FC. (US equivalent: Bostik 1100 FS) Expected usage of adhesive is: 28 metres (92 foot) per 600ml sausage.

- Turn the Ecoglo strip back to right side up and press on to the step.
- Apply downward pressure to ensure a good bond along its full length.
- If any adhesive squeezes out around the edges, wait until it cures before removing by trimming off with a box-cutter type cutting blade.
- Immediately following installation close off the area for a period of 2-3 hours to avoid the Ecoglo strip being moved whilst the adhesive is in the early stages of "cure".

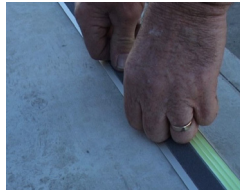



VISIBLY BETTER

G Series Installation Instructions

Tools Required

- Rubbing Alcohol or Acetone
- Premium Polyurethane adhesive/sealant
 - o Bostik 915 or Bostik 110 are recommended
- Caulking gun
- Roller
- Brush and Pan
- Paint Scraper
- Soft Cloth
- Box Cutter
- Painters tape

Installation procedure

- Ensure the mounting Surface is clean of dirt, dust and debris.
- If a sealant has been applied to the concrete, we recommend contacting your local adhesive representative to check compatibility.
- Lay the Ecoglo strips upside down and clean off any possible residue from the underside.
- Using a caulking gun apply a 2mm bead of the recommended polyurethane adhesive along the full length of the underside of the strip.
 - o Note: Expected usage of adhesive is 50 feet per 10.2 Oz tube.
- Turn the Ecoglo strip back to the right side up and press onto the surface.
- Apply downward pressure using a roller to ensure a good bond along its full length.
- If any adhesive squeezes out around the edges, wait until it cures before removing by trimming off with a box-cutter type of cutting blade.
- Apply painters tape to keep pressure on strips while adhesive cures.
- Immediately following installation close of the area for a period of 8 hours to avoid the Ecoglo strip being moved while the adhesive is in the early stages of cure.
- Remove tape after the 8 hours of curing.



ECOGLO INC.

241 Main St., Suite 100 Buffalo, New York 14203

Tel (888) 679-4022 Fax (877) 679-4022

www.us.ecoglo.com



Handrail Strip Installation Guide

Tools required

- Methylated spirits
- Glue gun
- Glue
- Roller
- Brush and pan
- Paint scraper
- Soft cloth
- Concrete Screws
 - 8 x 32mm (1 1/4 inch) countersunk square (#1) Stainless Steel AB self tapping screw.
- Anchor – 6mm x 30mm (0.25 x 1 3/16 inches) plastic anchor



2

Preparation of Surface

- Thoroughly clean the surface with an industrial strength cleaner.
- Remove any paint or sealant and then allow the surface to dry.



Alignment

- To ensure the Ecoglo Handrail Strip is installed in line, place a string line slightly off centre from the top end of the handrail to the bottom.
- This will serve as a guide for where to place each strip accurately onto the rail.

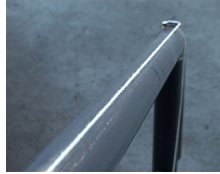
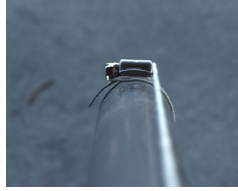

- Invert the Ecoglo Handrail Strip onto a holding "cradle"
- Apply the polyurethane adhesive with a cartridge glue gun.
- It is important that the nozzle of the gun is cut correctly so there is just sufficient adhesive applied within the two middle grooves along the base of the strip.
- **Note:** Ecoglo New Zealand installations use Bostik Seal n Flex FC, (US equivalent: Bostik 1100 FS) Expected usage of adhesive is: 80 metres (262ft, 6 inches) per 600ml sausage.

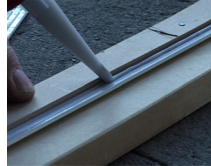
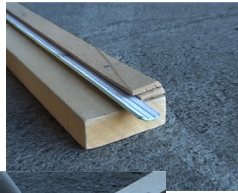

- Take the strip and place onto the handrail.
- Line up the outside edge with the string line.
- Press firmly down to spread the adhesive across the surface area of the underside of the strip.
- Repeat the above steps for the full length of the handrail with the inclusion of a 5mm (3/16") gap between each length of handrail.
- **NOTE:** The maximum recommended length for installation in outdoor situations is 1.5 metres (5 foot), with a minimum 5mm (1/8" inch) gap between lengths. This allows for thermal expansion in extreme weather conditions and also aids in water drainage off the step tread.

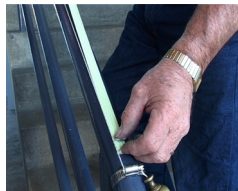

- If any adhesive squeezes out around the edges, wait until it cures before removing by trimming off with a box-cutter type cutting blade.
- Immediately following installation, close off the area for a period of 8 hours to avoid the Ecoglo strip being moved whilst the adhesive is in the early stages of "cure".